

MY SPACE Desking

FEATURES

- Quick and easy connection of components
- Certified sound absorption - class D

TECHNICAL INFORMATION

Combinations of workplaces with mounted desktop

Screen composition

- Made from 16 mm chipboard;
- Covered with 10 mm acoustic foam;
- Upholstered with fabric.

Metal beam

- Metal tube – 40x20 mm;
- With welded metal plates for fixing to screens;
- Powder coated metal.

Desktop

- 25 mm MFC (melamine) with 2 mm ABS edging;
- Metal fittings (metallic colour by default) are fixed under the desktop.

Feet and fixators

- Have to be ordered separately for specific screen combinations;
- Single foot and matching fixator are under one purchase code thus have the same metal colour.

MATERIALS

- Fabric: LUCIA, VELITO PRESTO, BERTA, SYNERGY, STEP/STEP Melange;
- Melamine: P (birch), T (beech), D1 (whitened oak), D2 (amber oak), U (walnut), M1 (white), N (grey);
- Metal: E (white), M (metallic), T1 (dark grey), A (black).

GUARANTEE

- 5 years

ORDERING EXAMPLE

Code structure

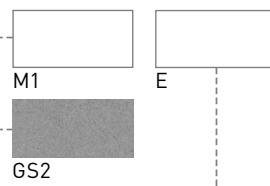

ASS140 - GS2 M1 E

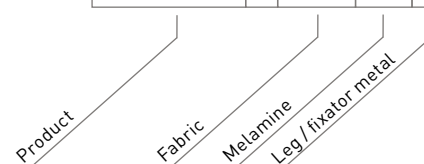

RANGE

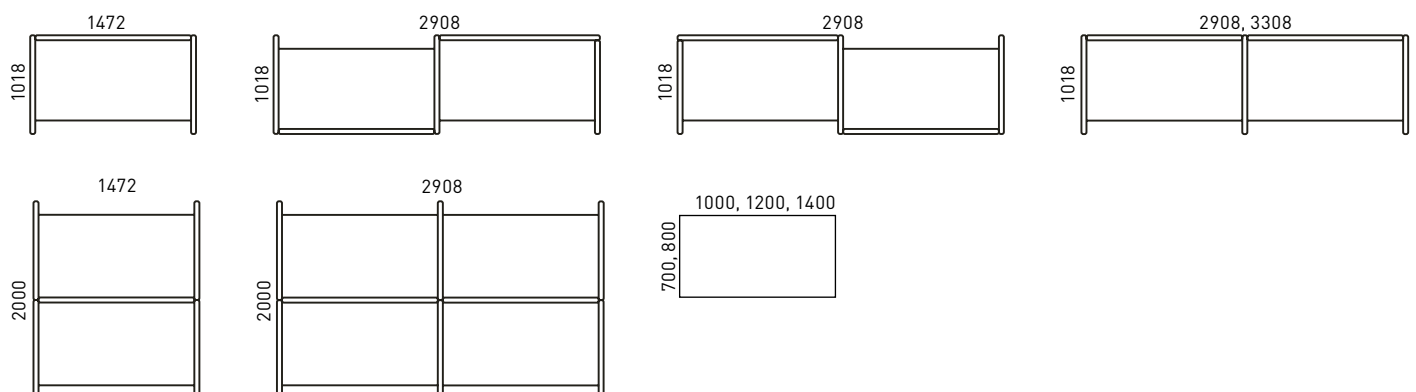

Separate parts for individual workplace combinations

- Additional sizes and different combinations are available by combining separate screens below;
- Please note that each panel is predrilled to hold a desktop.

L 1000
W 36
H 1273 (530)*

*Screen height above the
desktop

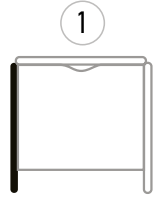

Left hand screen

ASL101

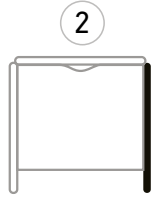

Right hand
screen

ASR101

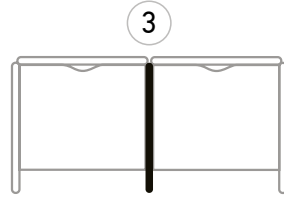

Central left hand screen

ASV103

L 1020; 1220; 1420; 1620
W 36
H 1273 (530)*

*Screen height above the
desktop

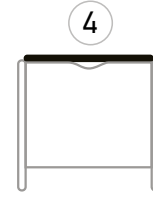

Front screen

ASP100 L=1000
ASP120 L=1200
ASP142 L=1400
ASP162 L=1600

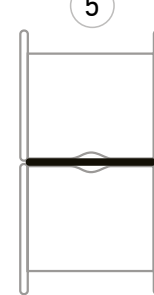

Central screen for double bench

ASV106 L=1000
ASV120 L=1200
ASP141 L=1400
ASP161 L=1600

L1 1000; 1200; 1400; 1600
W1 700; 800

Desktop

W1=700 W1=800

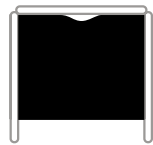

L1=1000	DSP100	DSP101
L1=1200	DSP120	DSP121
L1=1400	DSP140	DSP141
L1=1600	DSP160	DSP161

Legs and fixators

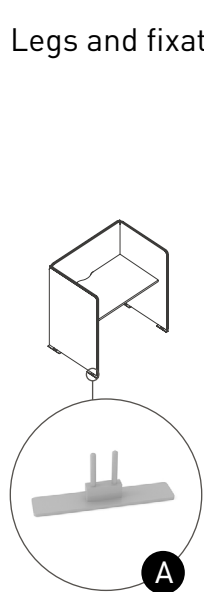

Metal I-shaped
leg

ASZ006

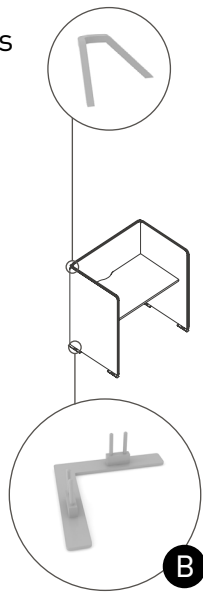

Metal L-shaped leg
and left fixator

ASZ001

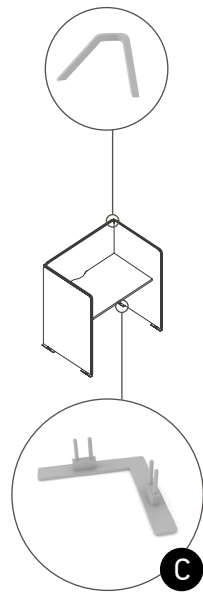

Metal L-shaped leg
and right fixator

ASZ002

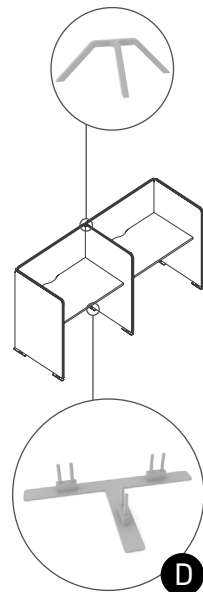

Metal T-shaped
leg and fixator for
the front screen

ASZ003

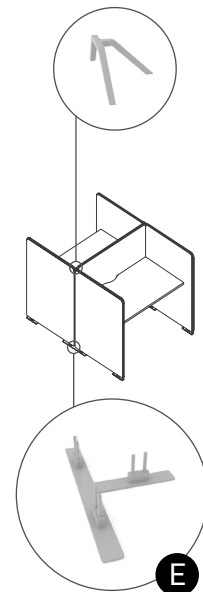

Metal T-shaped
leg and fixator for
the side screen

ASZ004

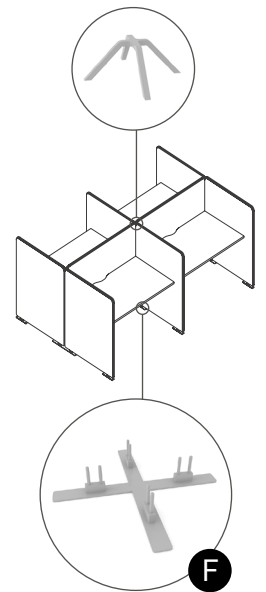

Metal X-shaped
leg and fixator

ASZ005

COMBINING EXAMPLE

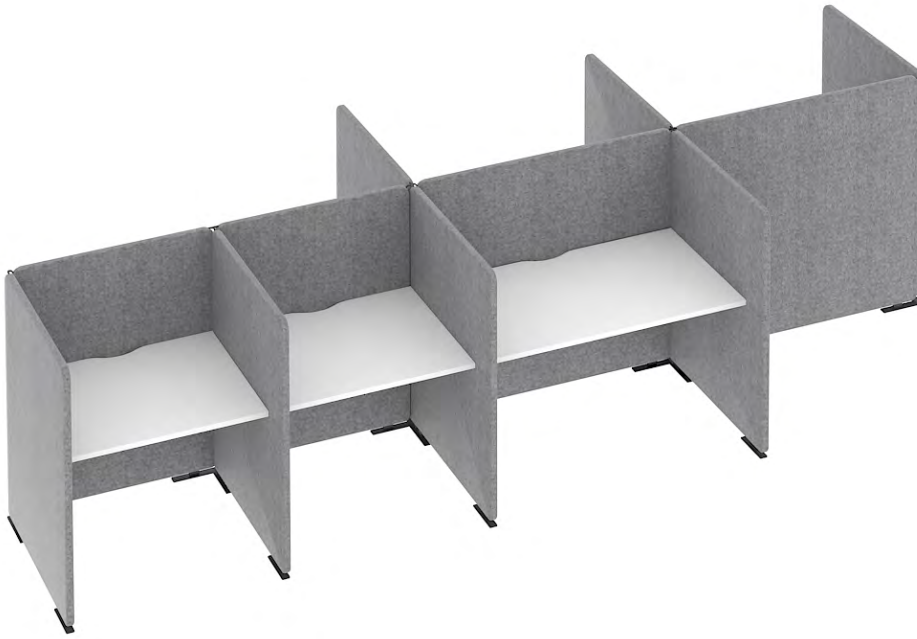

- 1
- 2
- 3
- 4
- 5

ASL101(2) + ASR101(2) + ASV103(2) + ASP100(2)+ ASP142 + ASP161 + ASV141 +

- A
- B
- C
- D

ASZ006(6) + ASZ001(3) + ASZ003 + ASZ005

